



# Surface Mount - Leaf Hinges

screw mount - stainless steel



## Hinges

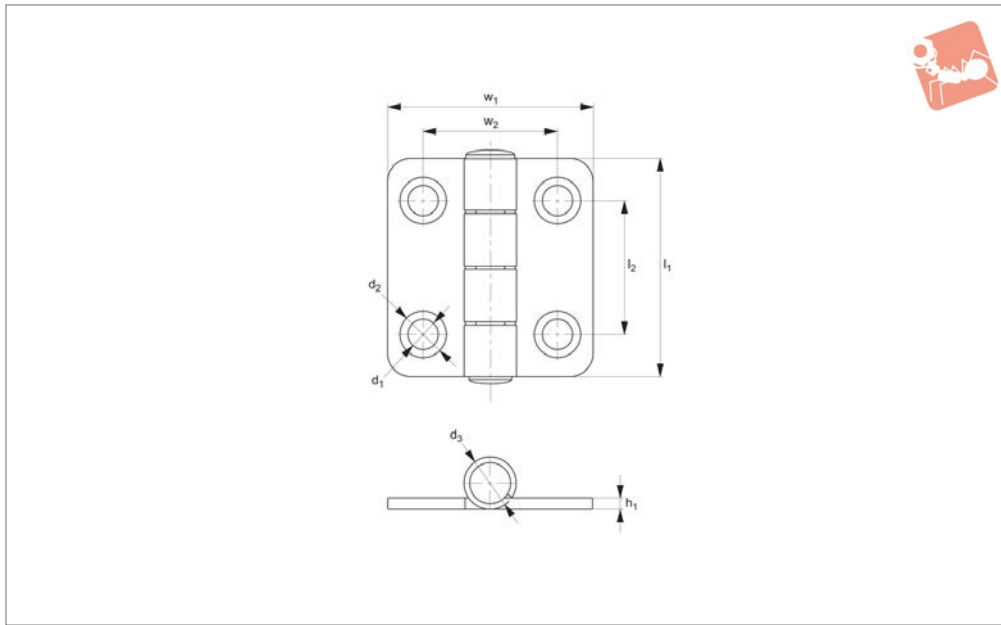

### S0738

HINGES

#### Material

Hinge: polishing stainless steel.

#### Technical Notes

Opening angle 180°.

Order No.	$h_1$	$l_1$	$l_2$	$w_1$	$w_2$	$F_x$ N	$F_y$ N	$d_1$	$d_2$	$d_3$
S0738.AW0037	2	37	22.5	35	23	745	1090	5.2	8	9



## Concealed hinges

For added security or a sleek enclosure design, concealed hinges offer the solution with mounting discreetly hidden away from view to avoid tampering.

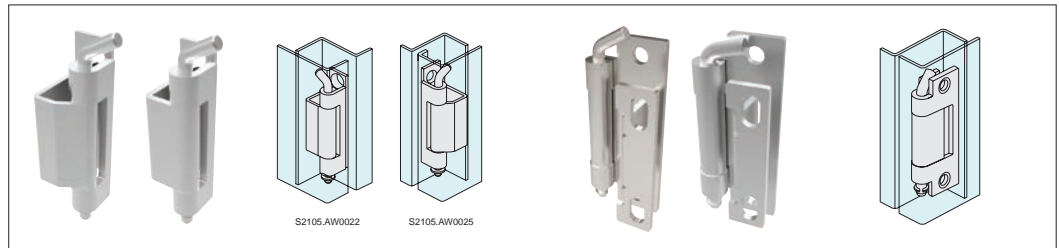

Concealed pivot hinges

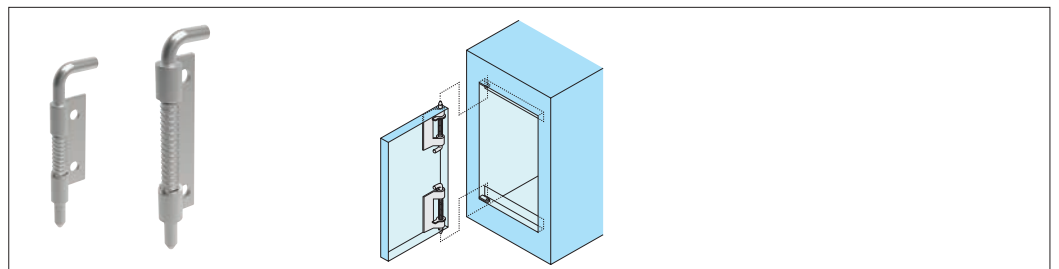

End mount concealed pivot hinges

## Door removal hinges

Door removal or lift-off hinges simplify removal of covers and panels to ease access for maintenance and repair, available in a selection of materials.

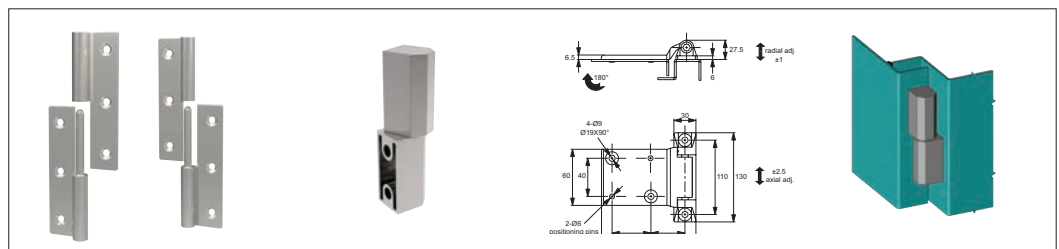

Lift off hinges

## Torque and positioning hinges

Torque and positioning hinges offer positive location of panels, screens and displays using constant friction for a firm hold.



Constant torque hinges

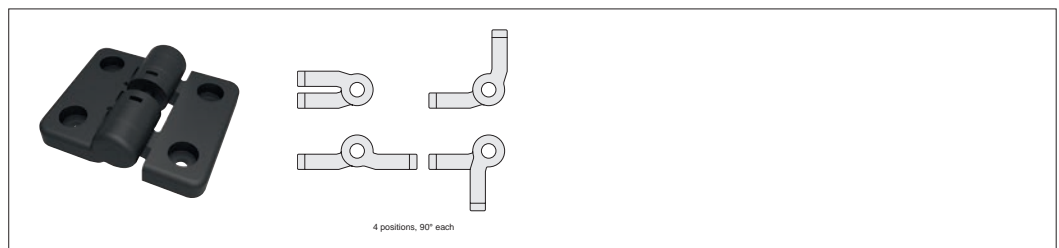

Detent positioning hinges



Wixroyd have a diverse range of hinges to suit most industrial applications in a wide range of materials and finishes.

Throughout our catalogue we refer to parts as being of a "Left" or "Right" type or hand. Which type you need, is most easily explained as follows;

Oriente your application so that when opened the door/panel comes towards you. With this orientation in mind, look to see on which side of the door/panel the hinges are mounted?

If the hinges are on the left side of the door/panel then you require "Left" type products. If the hinges are on the right side of the door/panel then you require "Right" type products.

The illustration on the right clearly indicates the layout and orientation of the door where a "left" or "right" product is used.

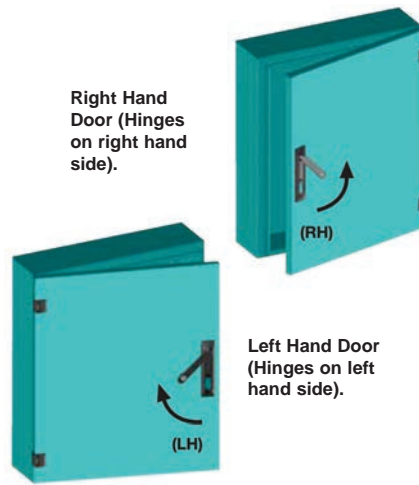

**Left or right type:  
Which do you need?**

## Hinges

External or surface mount hinges have a wide range of application on electrical panels, sheet metal enclosures, generators and heating and venting applications.

## External hinges

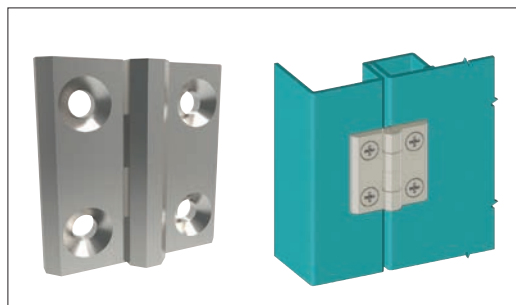

Surface mount hinges

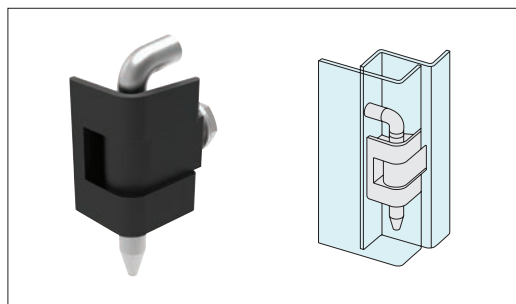

Corner hinges

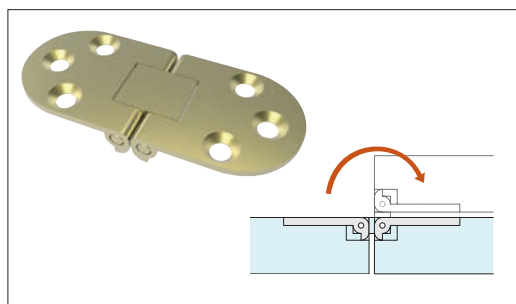

Flush mount hinges

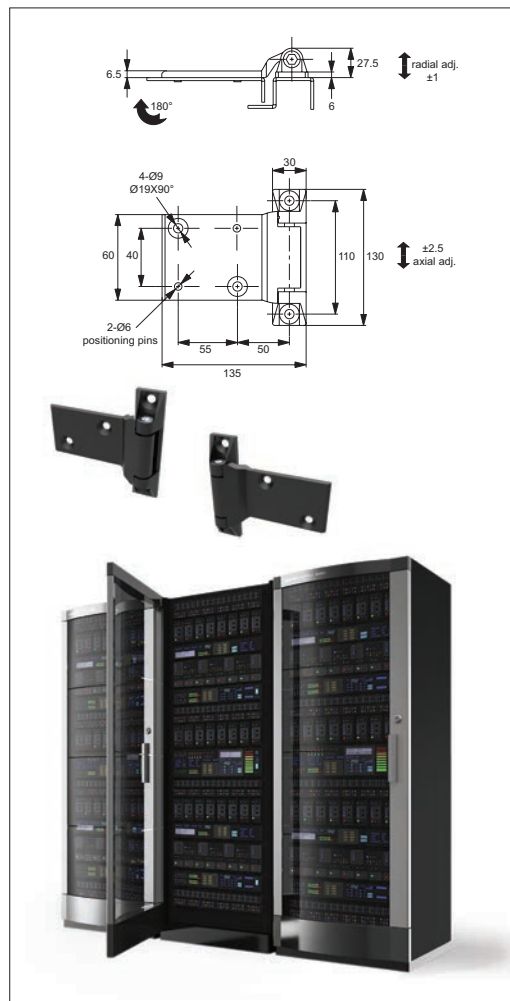

Surface mount hinges

HINGES

ov-WS0050-A-T-WS2300-A-TH1200-wide-range-of-solutions-b-rnh - Updated - 01-11-2022