

Levelling Feet - Fixed Feet

stainless steel, heavy duty



34650



Material

Stainless steel (AISI 304), with rubber pad (70 Shore A).
Stainless steel (AISI 316) version available on request.

Technical Notes

Load values refer to static loads, located at half the screw height. When vibrations or dynamic loads are present these values should be reduced.

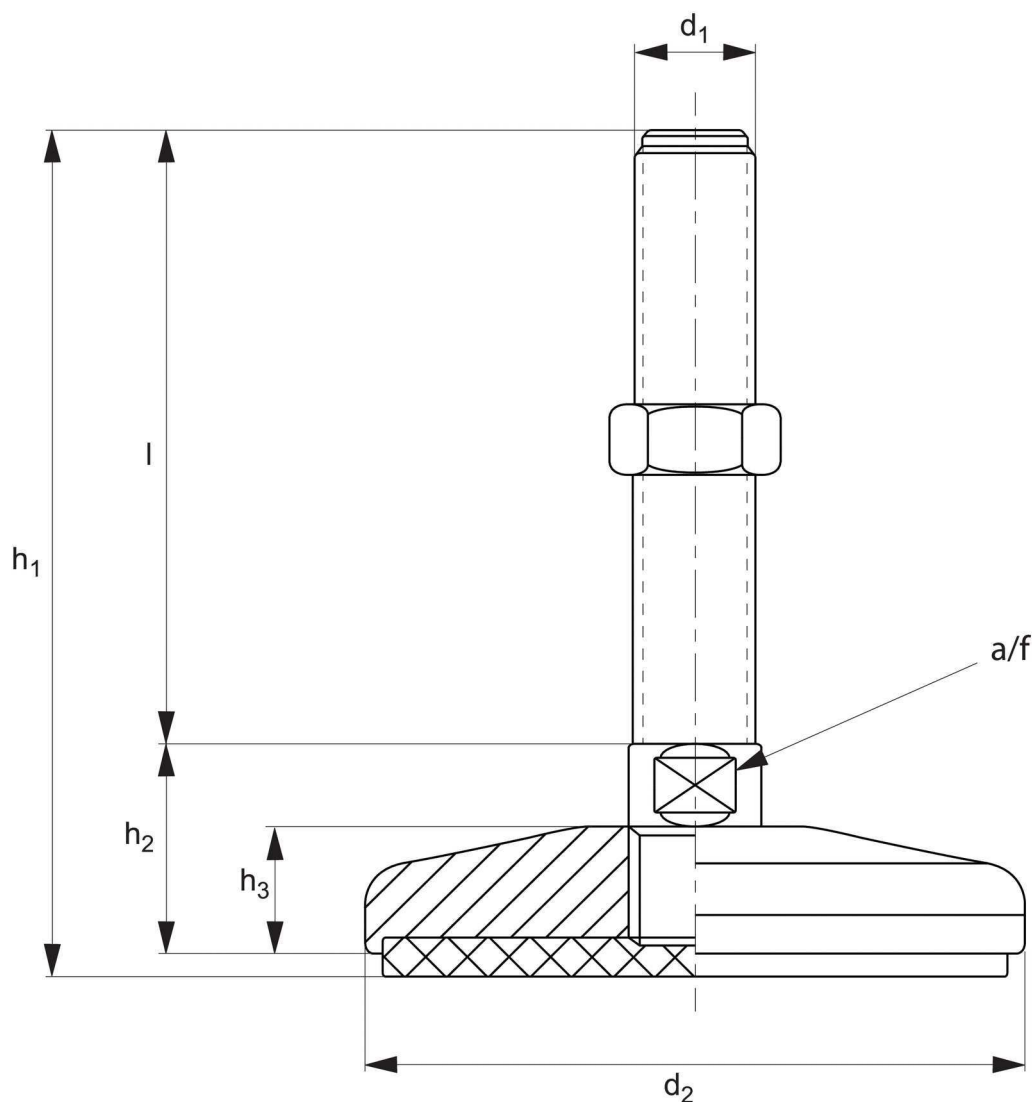

Order No.	d ₁	d ₂	l	h ₁	h ₂	h ₃	a/f	Max. load kN
34650.W1600	M16	80	100	134,5	31,5	19	17	30
34650.W1601	M16	80	150	184,5	31,5	19	17	30
34650.W1602	M16	80	200	234,5	31,5	19	17	30
34650.W1603	M16	100	100	136,0	33,0	20	20	40
34650.W1604	M16	100	150	186,0	33,0	20	20	40
34650.W1605	M16	100	200	236,0	33,0	20	20	40
34650.W2000	M20	80	100	134,5	31,5	19	20	35
34650.W2001	M20	80	150	184,5	31,5	19	20	35
34650.W2002	M20	80	200	234,5	31,5	19	20	35
34650.W2003	M20	80	225	259,5	31,5	19	20	35
34650.W2004	M20	100	100	136,0	33,0	20	20	45
34650.W2005	M20	100	150	186,0	33,0	20	20	45
34650.W2006	M20	100	200	236,0	33,0	20	20	45
34650.W2007	M20	100	250	286,0	33,0	20	20	45
34650.W2008	M20	120	100	138,0	35,0	22	20	45
34650.W2009	M20	120	150	188,0	35,0	22	20	45
34650.W2100	M20	120	200	238,0	35,0	22	20	45
34650.W2101	M20	120	250	288,0	35,0	22	20	45
34650.W2102	M20	159	100	139,0	36,0	23	20	50
34650.W2103	M20	159	150	189,0	36,0	23	20	50
34650.W2104	M20	159	200	239,0	36,0	23	20	50
34650.W2105	M20	159	250	289,0	36,0	23	20	50
34650.W2400	M24	80	100	136,0	33,0	19	20	40
34650.W2401	M24	80	150	186,0	33,0	19	20	40
34650.W2402	M24	80	200	236,0	33,0	19	20	40
34650.W2403	M24	80	225	261,0	33,0	19	20	40
34650.W2404	M24	100	100	137,0	34,0	20	20	50
34650.W2405	M24	100	150	187,0	34,0	20	20	50

Levelling Feet - Fixed Feet

stainless steel, heavy duty



34650

Order No.	d ₁	d ₂	l	h ₁	h ₂	h ₃	a/f	Max. load kN
34650.W2406	M24	100	200	237,0	34,0	20	20	50
34650.W2407	M24	100	250	287,0	34,0	20	20	50
34650.W2408	M24	120	100	138,0	35,0	22	20	50
34650.W2409	M24	120	150	188,0	35,0	22	20	50
34650.W2500	M24	120	200	238,0	35,0	22	20	50
34650.W2501	M24	120	250	288,0	35,0	22	20	50
34650.W2502	M24	159	100	139,0	36,0	23	20	60
34650.W2503	M24	159	150	189,0	36,0	23	20	60
34650.W2504	M24	159	200	239,0	36,0	23	20	60
34650.W2505	M24	159	250	289,0	36,0	23	20	60
34650.W3000	M30	120	100	139,0	36,0	22	26	60
34650.W3001	M30	120	150	189,0	36,0	22	26	60
34650.W3002	M30	120	200	239,0	36,0	22	26	60
34650.W3003	M30	120	250	289,0	36,0	22	26	60
34650.W3004	M30	159	100	140,0	37,0	23	26	70
34650.W3005	M30	159	150	190,0	37,0	23	26	70
34650.W3006	M30	159	200	240,0	37,0	23	26	70
34650.W3007	M30	159	250	290,0	37,0	23	70	70



Material

Stainless steel (AISI 304), with rubber pad (70 Shore A).
Stainless steel (AISI 316) version available on request.

Technical Notes

Load values refer to static loads, located at half the screw height.
When vibrations or dynamic loads are present these values should be reduced.





A Range of features to suit your application

To ensure you select the most suitable levelling feet for your application consider the following questions:

Product selection

- Tilting or fixed?
- Material required - steel, stainless or plastic?
- Load carrying capacity - light, medium or heavy duty?
(Review the quoted load capacities in the individual product tables).
- Bolt down feature required?
- Threaded or plastic insert required for mounting?
- Optional extras: hygiene seal, rubber pad, (subject to minimum quantity and selected model).

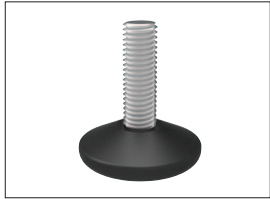

Fixed feet



Articulating levelling feet

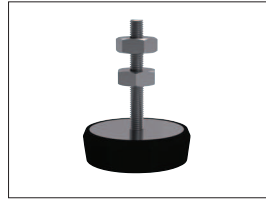

Machine mounts



Fulcrum screw

Key Types

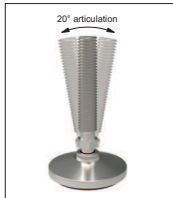

Articulation



Standard nylon base



Anti-slip base



Bolt down base



Hygienic seal

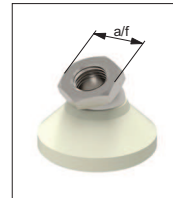

Hex for easy installation

Available features



Steel thread - Nylon base



Stainless thread - Nylon base



Steel thread - Steel base



Stainless thread - Stainless base

Materials



Weldable insert

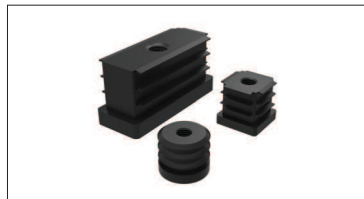

Hollow section insert

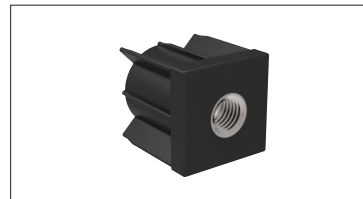

Hollow section bushed insert

Mounting inserts



For applications under greater loads and requiring increased precision of adjustment see our range of Precision Height Adjusters.



For applications exposed to extreme vibrations see our range of Anti-Vibration Mounts.

Additional technical information