

Threaded Plastic Insert - Round

with nickel plated brass bush

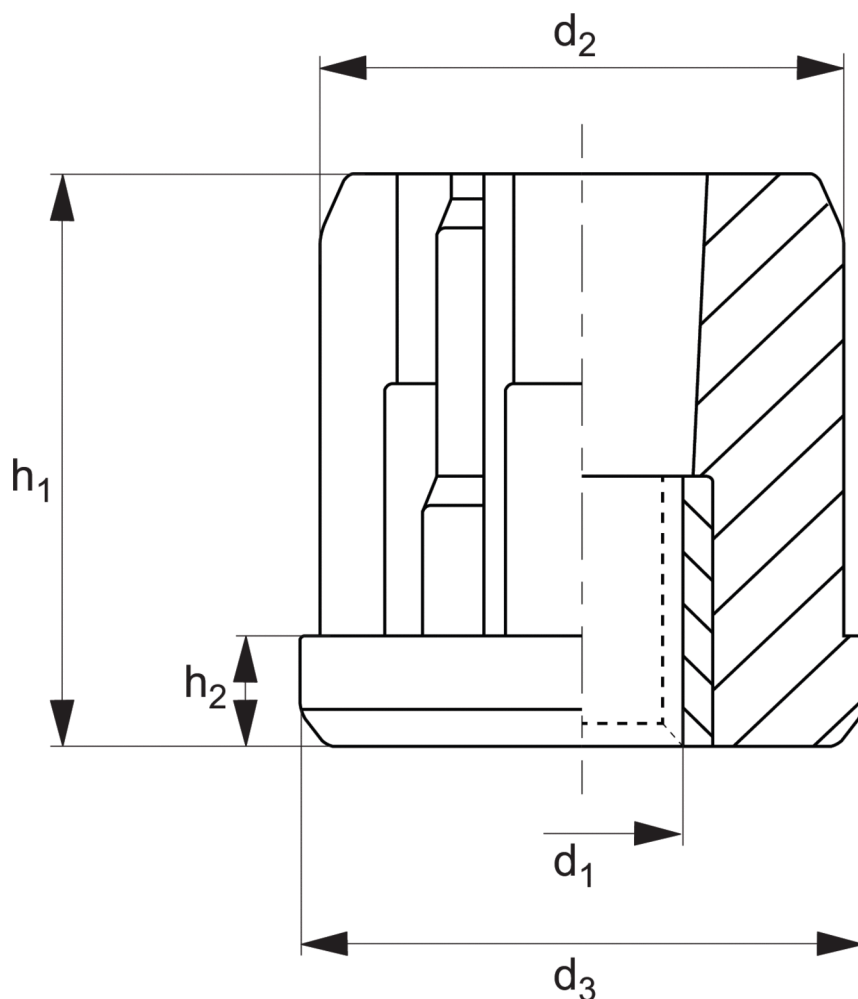

34693



round



Material

Moulding: polyamide, reinforced with fiber glass.
Insert: nickel-plated brass.

Notes -

Stainless steel inserts available on request.

Order no.	d ₁	d ₂	d ₃	h ₁	h ₂	Max. static load kN
34693.W0108	M8	28,5	30	35	6	3,2
34693.W0110	M10	28,5	30	35	6	3,2
34693.W0112	M12	28,5	30	35	6	3,2
34693.W0114	M14	28,5	30	35	6	3,2
34693.W0116	M16	28,5	30	35	6	3,2
34693.W0208	M8	35,5	38	43	8	5,5
34693.W0210	M10	35,5	38	43	8	5,5
34693.W0212	M12	35,5	38	43	8	5,5
34693.W0214	M14	35,5	38	43	8	5,5
34693.W0216	M16	35,5	38	43	8	5,5
34693.W0308	M8	39,5	42	42	8	6,5
34693.W0310	M10	39,5	42	42	8	6,5
34693.W0312	M12	39,5	42	42	8	6,5
34693.W0314	M14	39,5	42	42	8	6,5
34693.W0316	M16	39,5	42	42	8	6,5
34693.W0320	M20	39,5	42	42	8	6,5
34693.W0408	M8	45,5	48	49	11	8,0
34693.W0410	M10	45,5	48	49	11	8,0
34693.W0412	M12	45,5	48	49	11	8,0
34693.W0414	M14	45,5	48	49	11	8,0
34693.W0416	M16	45,5	48	49	11	8,0
34693.W0420	M20	45,5	48	49	11	8,0
34693.W0508	M8	47,5	50	49	11	8,5
34693.W0510	M10	47,5	50	49	11	8,5
34693.W0512	M12	47,5	50	49	11	8,5
34693.W0514	M14	47,5	50	49	11	8,5
34693.W0516	M16	47,5	50	49	11	8,5
34693.W0520	M20	47,5	50	49	11	8,5

Threaded Plastic Insert - Round

with nickel plated brass bush



34693

Order no.	d ₁	d ₂	d ₃	h ₁	h ₂	Max. static load kN
34693.W0614	M14	57,5	60	50	12	10,0
34693.W0616	M16	57,5	60	50	12	10,0
34693.W0620	M20	57,5	60	50	12	10,0
34693.W0624	M24	57,5	60	50	12	10,0
34693.W0714	M14	56,5	60	50	12	10,0
34693.W0716	M16	56,5	60	50	12	10,0
34693.W0720	M20	56,5	60	50	12	10,0
34693.W0724	M24	56,5	60	50	12	10,0
34693.W0814	M14	55,5	60	50	12	10,0
34693.W0816	M16	55,5	60	50	12	10,0
34693.W0820	M20	55,5	60	50	12	10,0
34693.W0824	M24	55,5	60	50	12	10,0



Material

Moulding: polyamide, reinforced with fiber glass.

Insert: nickel-plated brass.

Notes -

Stainless steel inserts available on request.



A Range of features to suit your application

To ensure you select the most suitable levelling feet for your application consider the following questions:

Product selection

- Tilting or fixed?
- Material required - steel, stainless or plastic?
- Load carrying capacity - light, medium or heavy duty?
(Review the quoted load capacities in the individual product tables).
- Bolt down feature required?
- Threaded or plastic insert required for mounting?
- Optional extras: hygiene seal, rubber pad, (subject to minimum quantity and selected model).

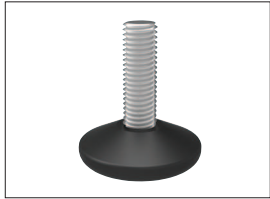

Fixed feet



Articulating levelling feet

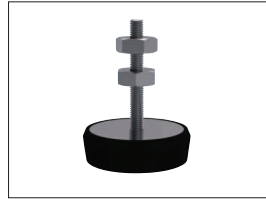

Machine mounts



Fulcrum screw

Key Types

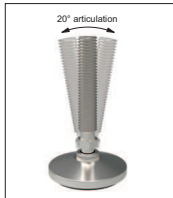

Articulation



Standard nylon base



Anti-slip base



Bolt down base



Hygienic seal

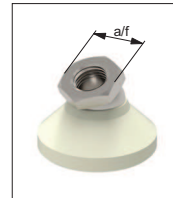

Hex for easy installation

Available features



Steel thread - Nylon base



Stainless thread - Nylon base



Steel thread - Steel base



Stainless thread - Stainless base

Materials



Weldable insert

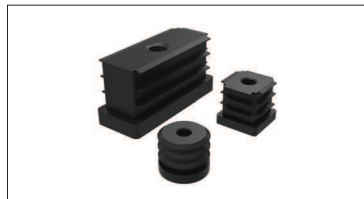

Hollow section insert

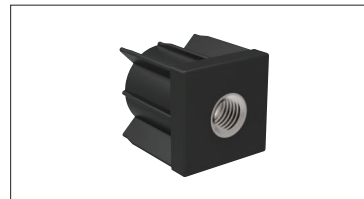

Hollow section bushed insert

Mounting inserts



For applications under greater loads and requiring increased precision of adjustment see our range of Precision Height Adjusters.



For applications exposed to extreme vibrations see our range of Anti-Vibration Mounts.

Additional technical information