



Hygienic Nuts - Female

304 stainless steel



Sealing Screws

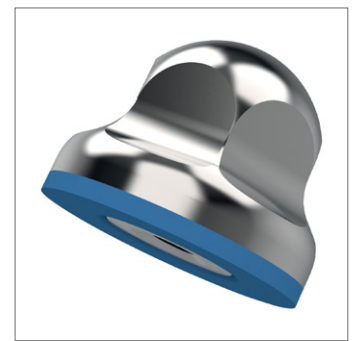
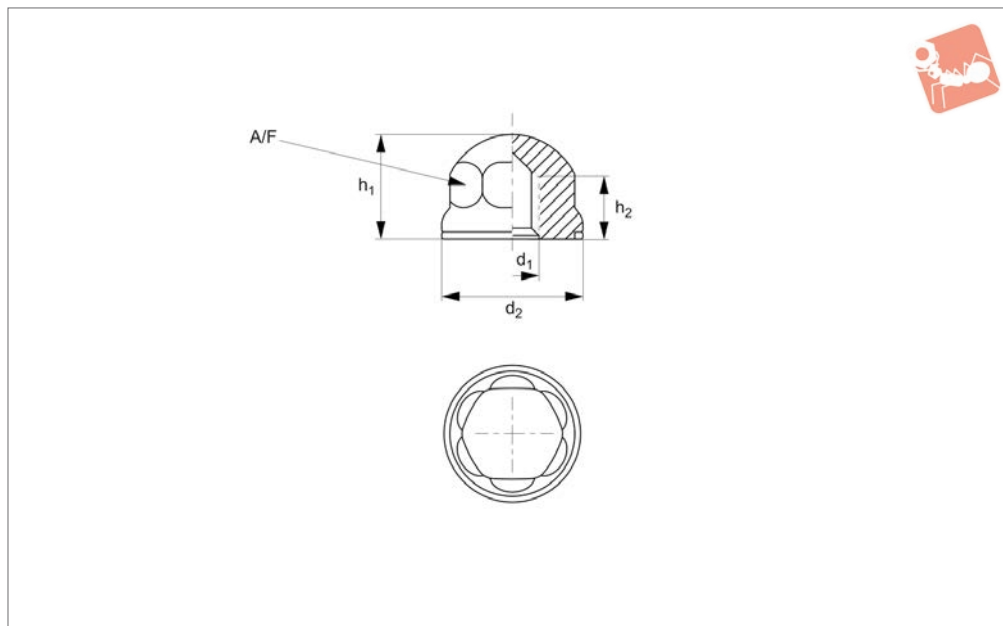

36638

SEALING SCREWS

Material

AISI 304 stainless steel high-gloss polished dome-nut, FDA blue silicone gasket, 3-A accepted. Available on request in AISI 316.

Technical Notes

For use in hygienic areas, components can be mounted without dead spaces. Sealing ring is hydrogenated acrylonitrile butadiene rubber (H-NBR), hardness 85±5

shore A, temp range -25°C to +150°C, blue.

Polished finish Ra < 0,8μ

Order No.	d ₁	d ₂	h ₁	h ₂	A/F
36638.W0003	M 3x0,5	15	12	8	HEX 10
36638.W0004	M 4x0,7	15	12	8	HEX 10
36638.W0005	M 5x0,8	19	17	12	HEX 14
36638.W0006	M 6x1	19	17	12	HEX 14
36638.W0008	M 8x1,25	24	23	15	HEX 17
36638.W0010	M10x1,5	24	23	15	HEX 17
36638.W0012	M12x1,75	24	23	15	HEX 17
36638.W0014	M14x2	30	28	20	HEX 22
36638.W0016	M16x2	30	28	20	HEX 22
36638.W0020	M20x2,5	35	34	25	HEX 27
36638.W0024	M24x3	42	40	30	HEX 32

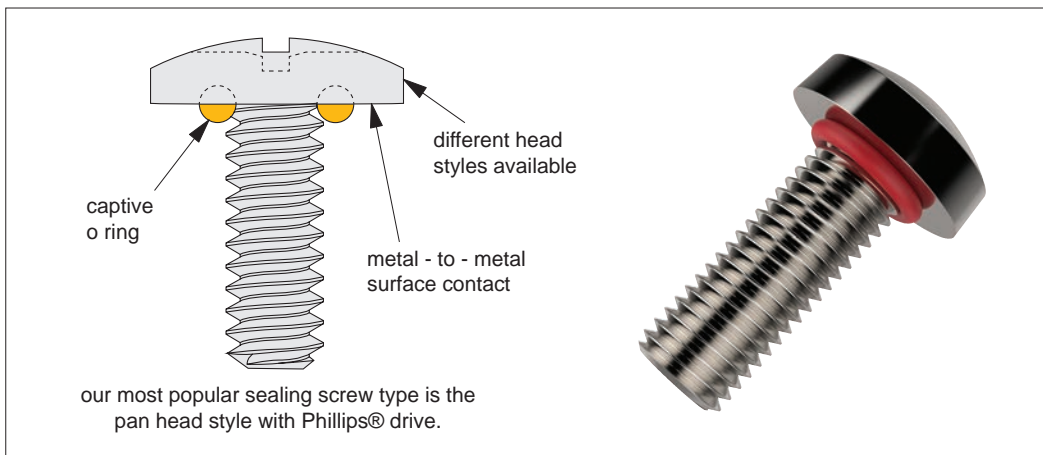

Why use Sealing Screws?

An ordinary screw lacks seal protection, allowing dirt, fluids, gases etc to infiltrate and damage sensitive devices. Sealing screws provide bi-directional sealing protection to systems where screws are used, to protect them against dirt, chemicals, water or other contaminants, which (without the screw seal), may penetrate and cause damage, or alternatively where gases and liquids may leak out.

Sealing screws are designed and manufactured with a precision engineered groove beneath the head of the fastener to accommodate the integral O-ring. As the fastener is tightened, the O-ring is compressed, squeezing it between the groove and mating surface to complete the seal. The design of the groove controls the amount of compression of the O-ring, and because O-rings retain their elastic memory, the screws are reusable time after time.

The seal provides bi-directional sealing which provides a total barrier seal against internal or external conditions (water, fluids, chemicals, dirt, air, contaminants etc) which could otherwise penetrate and damage systems. The screws are very easy to use and do not need any special preparation or re-tightening.

There are a range of O-ring materials that can resist virtually all chemical and environmental conditions. We can also provide sealing screws (on request) to military specifications (MILSPEC).

Sealing Screw Heads

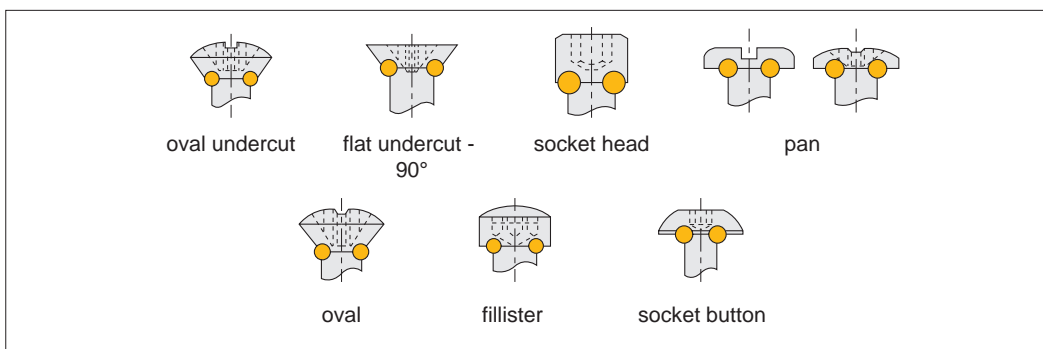

Ordering Options



36630 - Pan head - Phillips® Security and Torx® options

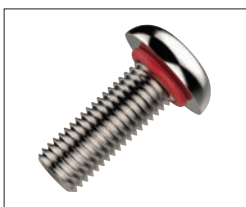

36631 - Button Hex-head Security and Torx® options

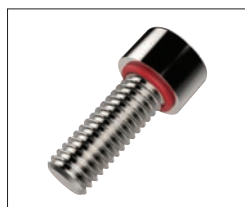

36633 - Socket Head Security and Torx® options

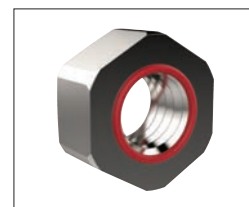

36636 - Hexagon Nut



Optimal performance

When using self-sealing screws a high pressure seal is formed along the thread's contact surface when torqued.

If possible, and to ensure maximum sealing performance, we recommend a clearance hole (see table below), this creates room for the O-ring to flow into.

The aim is to ensure full metal-to-metal contact between the underside of the fastener and the mounting surface.

If a clearance hole cannot be utilized, the O-ring will still function as it will compress to fill the gap between the male and female surfaces.

We also have a range of sealing nuts to complement our range of sealing screws. These sealing nuts often eliminate the need for gaskets, compounds and surface preparation. They are widely used in the hydraulic, pneumatic or fuel systems industries.

They are invaluable when a vacuum needs to be created and provide a complete seal when gaseous or liquid pressure is a factor. Domed nuts are self-sealing and provide exceptional vibration resistance.

Some of the typical applications for our sealing screws include:

- Motors
- Cabinets and enclosures
- Sensors and instrumentation
- Internal combustion engines
- Gear pumps
- Fuel tanks
- Transmissions
- Gear boxes
- Air cylinders
- Pressure gauges
- Computer disk drives
- Motion control valves
- Missile tanks
- Wet wings

Self-sealing Screw

Applications

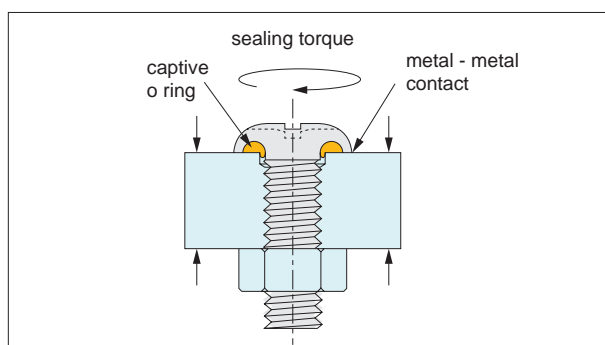

Thread Size	Standard Installation Torque
M3	0.6 Nm
M3.5	1.0 Nm
M4	2.2 Nm
M5	2.5 Nm
M6	8.5 Nm
M8	16 Nm
M10	30 Nm

Installation Torque

Nom. Size	Max clearance hole Ø
M2	2,44
M2,5	2,95
M3	3,45
M3,5	3,66
M4	4,55
M5	5,56
M6	6,66
M8	9,04
M10	11,05
M12	14,05
M14	16,05
M16	18,06

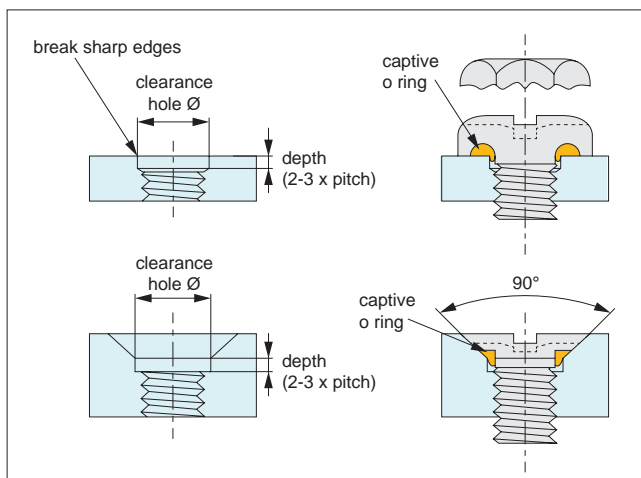





Clearance Hole Ø - Recommended

For optimal seal screw performance we recommend creating a clearance hole in the panel into which the O-ring can be fitted. This causes the O-ring to create a complete seal, and the clearance hole thus prevents extrusion into the metal when the screw is under pressure.

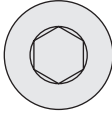

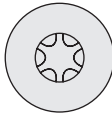
Drive Types

Schematic	Drive Types	Uses
	Hexagonal	Ideal for precision assembly. Most recommended where less surface area is available.
	Cross Drive (Phillips®)	Most recommended drive type. Provides good control in driving. Always use a driver bit of the proper size which is in good condition.
	Hexalobular (Torx®)	Positive-engaging, fast-locating method which transmits drive torque with less required downward pressure. Good fastening appearance.
	Security	These screws are impossible to remove without the special matching screwdriver.

We can provide Torx® heads and security/tamper-proof screws, as well as special threads, grooves and cross holes for safety wires, and a further range of styles such as captive screws, anti-vibration strips on the threads etc (for extreme vibration applications).

O ring Selection

Standard O rings are red silicone, but a further five O ring material types are readily available. The main factor to consider when selecting an O ring type is the environment in which it will be placed, and the temperature range it will be subjected to.

Material	Notes
Silicone (SI)	Our standard O ring type with a wide temperature range -60°C to +200°C. Resistant to moderate or oxidising chemical, but not generally oil or solvent resistant.
Fluorosilicone (FS)	Widely used in the automotive and aerospace industries as it has excellent resistance to fuel, oil and solvents. Standard temperature range -50°C to +170°C.
EPDM (EP)	These O rings are very suited for outdoor environments and are good for weather and water resistant applications having excellent ozone, steam and chemical resistance. Temperature range -50°C to +110°C.
Viton-fluorocarbon (VI)	These seals are widely used on aircraft engines and automotive fuel handling systems as they have excellent fuel, oil and solvent resistance. Standard temperature range -50°C to +200°C
Nitrile (NI)	Widely used as highly resistant to petroleum based substances, water and alcohols. Temperature range -50°C to +110°C.

Other O rings types can include Neoprene, Buna N, Teflon etc.



Materials

Our standard screw material is stainless steel (AISI 303, 1.4305). Other materials available are aluminium (non-magnetic and 1/3 weight of steel), brass (high electrical conductivity, non-magnetic and good corrosion resistance), titanium (low weight, very strong and highly corrosion resistant), stainless steel (A4, AISI 316).

Fasteners can be supplied to MILSPEC standards (MIL-S-82496A) on request.

Finishes

Finishes are dependent on the material you are wishing to coat and subject to minimum quantities.

Finish	Notes
Black Chrome (MIL-C-1458B)	Black chrome is a hard, non-reflective coating which is resistant to abrasion, heat and erosion. The black chrome surface is a dull, dark grey and may be waxed or oiled to darken surface.
Black Oxide Coating (MIL-C-13924B)	Black oxide is a uniform black coating for ferrous metals. Generally it is considered a decorative coating and provides only very limited corrosion protection under mild corrosion conditions.
Cadmium	Cadmium is a bright, silvery white plating. Supplementary treatments for Type II can be golden, iridescent, amber, black or olive drab.
Passivate (QQ-P-35/MIL S-500SC)	Passivation is a process designed to remove foreign metals from the surface of stainless and corrosion resistant steels.
Phosphate Coating Light (TT-C-00490B)	Phosphate coating is a light coating for use as a base paint.
Gold (MIL-G-45204B)	Yellow to orange colour depending on proprietary process used. Will range from matt to bright finish depending on base metal. Good corrosion resistance and high tarnish resistance.
Nickel (QQ-N-290A)	Nickel is a corrosion protective plating for steel, zinc and zinc alloys as well as copper and copper alloys.
Zinc (QQ-Z-325C)	The primary use of chromate finishes on zinc is to retard or prevent formation of white corrosion products on zinc surfaces.



Shoulder Screws

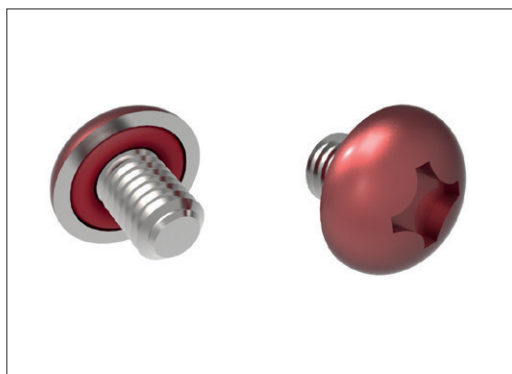

Painted Heads



Captive Screws



Security Heads (Tamper Proof)