

# Durasoft Roller

roller only

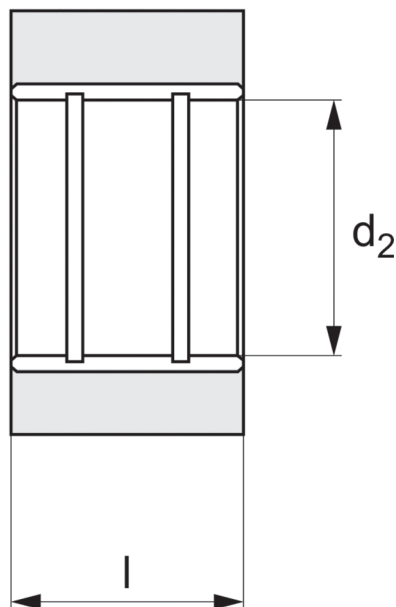

# 60640

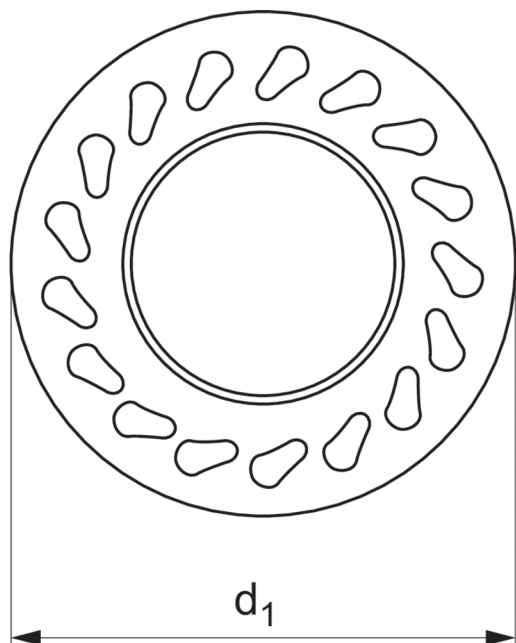

### Material

Urethane bonded to a steel insert.  
Hardness from 35-95 durometer  
(Shore A).

### Technical Notes

Roller only - allows for custom mounting.

### Tips

Durasoft rollers have "teardrop" holes to allow the roller to flex for firm but non-damaging contact.

Order No.	Durometer	d <sub>1</sub>	l	d <sub>2</sub> min./max.
60640.W1003	35	63,5 (2,5")	23,37	28,58/28,65
60640.W1006	60	63,5 (2,5")	23,37	28,58/28,65
60640.W1008	80	63,5 (2,5")	23,37	28,58/28,65
60640.W1009	95	63,5 (2,5")	23,37	28,58/28,68
60640.W1013	35	63,5 (2,5")	49,28	31,80/31,90
60640.W1016	60	63,5 (2,5")	49,28	31,80/31,90
60640.W1018	80	63,5 (2,5")	49,28	31,80/31,90
60640.W1019	95	63,5 (2,5")	49,28	31,80/31,90
60640.W1023	35	101,6 (4")	23,37	31,80/31,90
60640.W1026	60	101,6 (4")	23,37	31,80/31,90
60640.W1028	80	101,6 (4")	23,37	31,80/31,90
60640.W1029	95	101,6 (4")	23,37	31,80/31,90
60640.W1033	35	101,6 (4")	49,28	31,80/31,90
60640.W1036	60	101,6 (4")	49,28	31,80/31,90
60640.W1038	80	101,6 (4")	49,28	31,80/31,90
60640.W1039	95	101,6 (4")	49,28	31,80/31,90



## Wixroyd Rollers

### Product overview

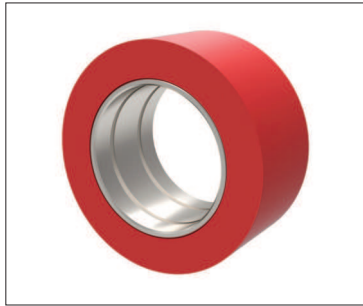

**Solid rollers** - have a smooth surface and a solid body

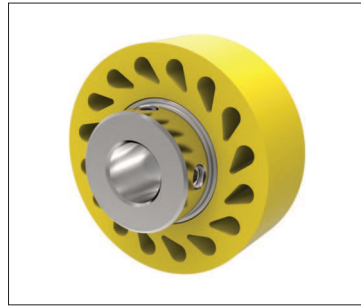

**Durasoft rollers** - have a smooth contact surface with teardrop holes to allow greater roller compression under load.



**Finned rollers** - are grooved and provide self-cleaning as dirt, debris and liquid pass under the contact surface of the roller.

### Durability levels



20 durometer:  
Stiff foam rubber



35 durometer:  
Pencil rubber top



60 durometer:  
Car tyre



80 durometer:  
Skateboard wheel



90 durometer:  
Hockey puck

### Applications

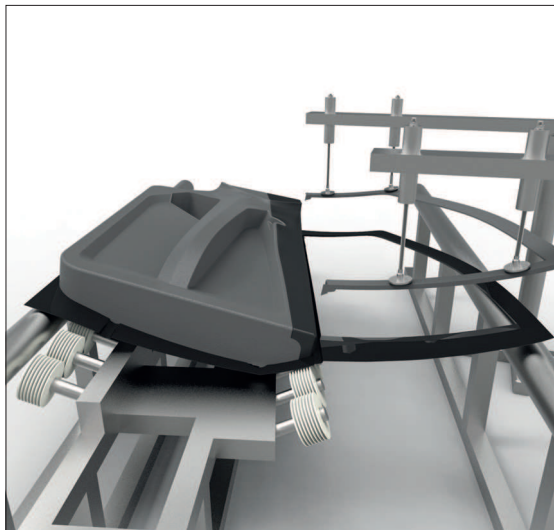

Rollers are used in car manufacturing to guide and align doors during bonding and curing applications



Bumpers have found their way into commercial exercise equipment to provide protection and stability during use.



## Materials colour guide and properties



**Nitrile and neoprene**

Nitrile - one colour

Neoprene - one colour

**Urethane**

35 Durometer (Yellow)

60 Durometer (Blue)

80 Durometer (Red)

95 Durometer (Orange)

Base Elastomer	Chemical Name	Advantages	Disadvantages	Max. Temp	Min. Temp
Nitrile	Nitrile Butadiene	Resistant to petroleum, oil, alcohol & abrasion.	Affected by degreaser solvents.	Continuous 79°C Intermittent 107°C	-51°C
Neoprene	Chloroprene	Flame and weather resistant. Resistant to Petroleum, oil, ozone & high temp.	Affected by phosphate hydraulic fluids, aromatic hydrocarbons.	Continuous 93°C Intermittent 121°C	-40°C
Urethane	Di-Isocyanate Polyurethane	Highest abrasion resistance, strength & load bearing. High elongation, hardness. Resistance to Ozone & Oxygen.	Affected by ether, esters, acid, aromatics, alkalis.	Continuous 93°C Intermittent 121°C	-54°C

## Material properties

Property:	Nitrile	Neoprene	Urethane
Tensile Strength	3 3	3 3 3	3 3 3 3
Ozone Resistance	3	3 3	3 3 3 3
Cut Resistance	3 3	3 3 3	3 3 3 3
Abrasion Resistance	3 3	3 3 3	3 3 3 3

Resistance To:	Nitrile	Neoprene	Urethane
Compression Set	3 3	3 3 3	3 3 3
ASTM #1 Oil	3 3 3 3	3 3	3 3 3 3
ASTM #2 Oil	3 3 3 3	3 3	3 3 3 3
Reference Fuel B	3 3 3	3 3	3 3 3 3
Ketones: MEK	3	3 3	3
Aromatics: Toluene	3 3 3	3	3 3 3 3
Aliphatics: Hexane	3 3 3 3	3 3 3	3 3 3 3
Ethyl Acetate	3	3 3 3	3
Cellosolve	3 3	3 3 3 3	3
Methylene Chloride	3	3	3 3 3 3
Trichloroethylene	3	3	3 3 3 3
Diethylene Glycol	3 3 3 3	3 3 3 3	3 3 3
Isopropyl Alcohol	3 3 3	3 3 3	3 3 3
Caustics: 10% NaOH	3 3 3	3 3 3	3
Acids: H2SO4	3 3	3 3 3	3

Excellent 3 3 3 3    Good 3 3 3    Fair 3 3    Poor 3



The tables below show the maximum theoretical radius loads that can be applied to the respective bearings. Refer to individual product tables to identify bearing type supplied with roller.

### Standard bearings

Bearing Type	Inside diameter (inches)	Outside diameter (inches)	Width (inches)	Load (Kg)	Speed (rpm)
A - Standard Double	.313/.317	.870/.875	.498/.502	55	50
				36	100
				24	250
				20	500
B - Standard Single	.500/505	1.245/1.250	.370/.380	119	50
				79	100
				51	250
				47	500
C - Standard Double	.500/505	1.245/1.250	.745/.755	192	50
				128	100
				83	250
				70	500

With the calculations above, typical life is approximately 2500 hours.

### Clutch bearings

Bearing Type	Inside diameter (inches)	Outside diameter (inches)	Width (inches)	Load (Kg)	Speed (rpm)
H	.3745/.3750	.6245/.6255	.865/.875	167	33
				146	50
				116	100
				85	250
I	.6245/.6250	.8745/.8755	.990/1.000	277	33
				242	50
				192	100
				142	250

With the calculations above, typical life is approximately 1,000,000 revolutions or 500 hours. The bearings are shielded and pre-lubricated for life with grease.

A clutch roller can only be used in one direction, as shown. See data table for clutch direction of particular part.

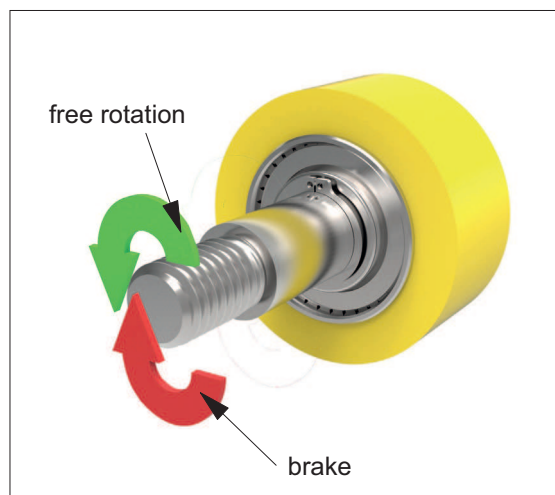

Left clutch bearing

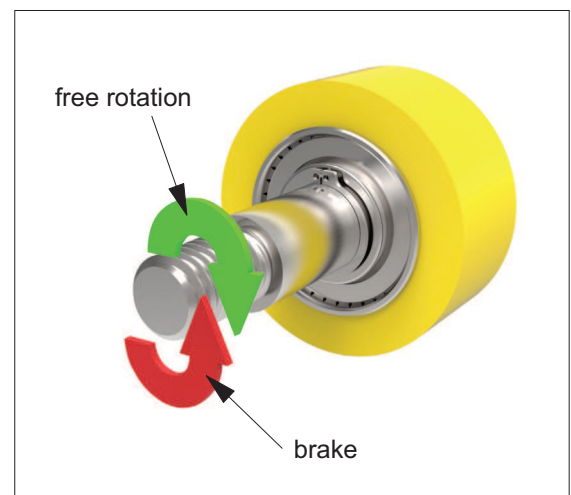

Right clutch bearing