

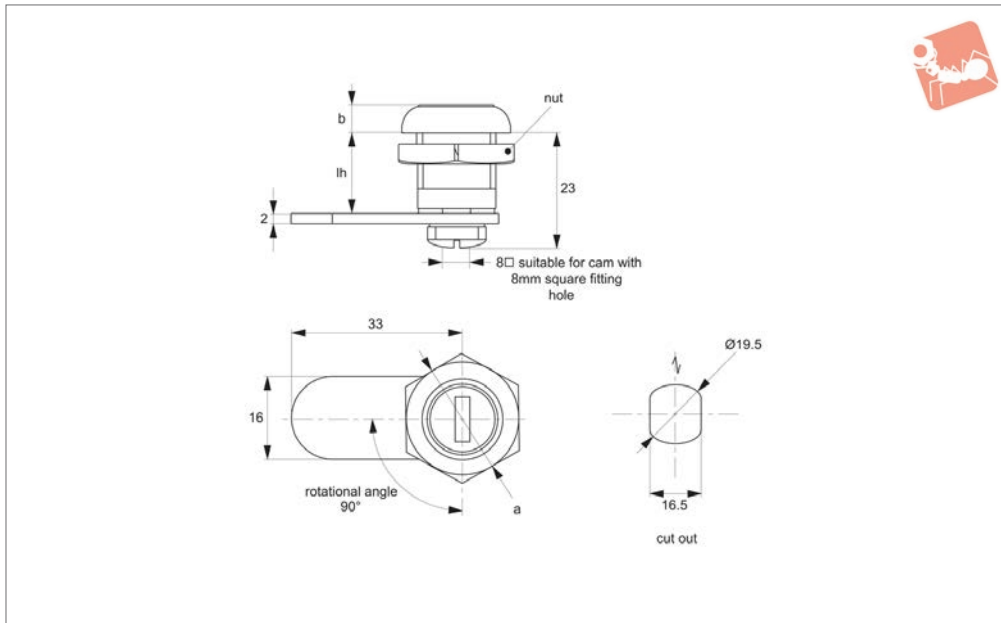

# Mini Cam Lock

cam lock - fixed grip



## A2383

CAM LOCKS

### Material

Body & insert: die cast zinc, bright chrome plated.

Fixed grip: zinc.

**Supplied with:** Nuts, Cam and Keys: two per lock.

### Tips

Ideal for use in metal cabinets, drawers

and machinery covers etc.

Due to compact size of cam and lock body there is no need to remove cam during installation.

Keyed to differ model has a max. 100 key combinations.

Type Three -  $90^\circ$  key rotation, key non-removable when in unlocked position.

Quarter-turn opening. Locks have dust cover.

Order No.	a	b	lh
A2383.AW0010	22.0	5.5	15.5



When selecting a Wixroyd Cam Latch for your application, you need to answer these questions:

1. Which installation cut out?
2. Which body style?
3. Which locking key?
4. Which accessories?
5. Which cam type and size?

## Step 1: Which installation cut out?

### Cut out

All our Flexi-System cam latches use a standard installation cut out 22,2 dia, 20,2 square, for maximum flexibility. We also provide a number of alternative cut out dimensions for legacy/historical installations.

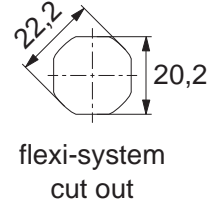

## Step 2: Which body style?

### Material and finish

Select from our variety of die cast zinc, polyamide plastic and stainless versions.



Die-cast zinc chrome plate

Die-cast zinc black coated

Polyamide black

Stainless steel

### Actuation and locking method

Standard insert driver type, cylinder lock or wing handle type.



Insert driver

Cylinder lock

Wing handle

### Number of latching points in application

Typically single point latching is required, but the Wixroyd Flexi-System also provides multi-point latching (typically 3 point - at lock point, top and bottom of cabinet).



Single point

Two point

Multi-point

## Step 3: Which locking key?

### Standard insert driver keys

Our range of insert driver cam latches require a simple key to actuate. Refer to part A0102 and A0103 for correct keys.



### Cylinder locking

Our cam locks with cylinder locks are supplied with two keys per lock. Available as keyed alike or keyed to differ locks.



## Step 4: Which accessories?

- Multi-point latching: use our rod set A0303 to A0325 for suitable rods and rod guides.
- Finger pulls: easily installed with any of our flexi-system cam bodies, finger pull no. A0352 is a simple, cost effective handle for your cabinets.
- Dust Cap: to reduce material ingress.

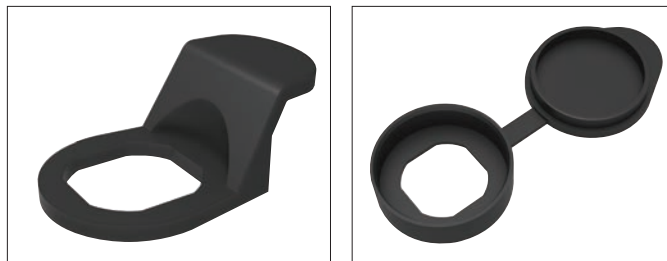

# Selecting the Correct Cam Latch or Lock

## Cam Latches and Locks

### With or without "Projection"

Different cam bodies require cams either with or without projection.

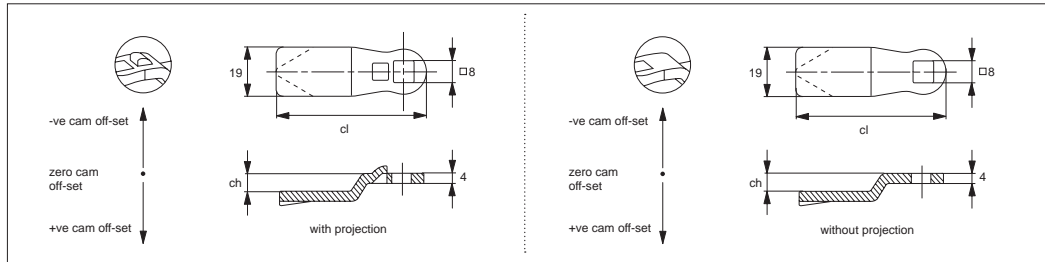

With projection cams prevent turning of the cam over 45°, but is not suited to all cam bodies. For correct projection type please see individual cam body technical pages.

### Number of Latching Points

Single point cams are suitable where just single point latching is required. Multi-point cams are for applications requiring 2 or 3 latching points.

### Step 5: Which cam type and size?

Wixroyd cams are available in a number of different materials; zinc plated steel, stainless steel (AISI 304) and black plastic.

### Cam off-set (dimension ch)

To ensure your cam fully and correctly engages with the frame of your door the correct cam off-set must be selected. A cam off-set can be either negative (-ve) or positive (+ve).

### Cam length (dimension cl)

This impacts the reach of the cam to door frame and hence impacts positioning of cam body for installation. Cam length is measured from the centre of the cam fixing hole to the cam's leading edge. Most typically cams are 45 mm in length.

Use formula to calculate ch (required cam off-set), and refer to the cam selection chart.

- ch = h - lh where;
- ch = the required cam off-set/height
- h = grip length (distance between inside of latch face and front of cam).
- lh = body length of cam latch/lock to be used (see example below)

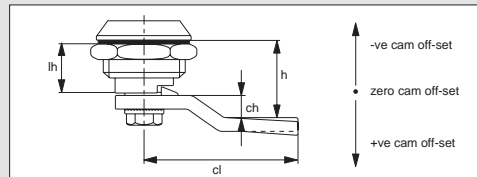

### Calculation of correct cam off-set

This is the most important aspect of the selection process.

### Example one

Cam body A1003.AW0010 has been selected for the application. If we refer to the data sheet for this part, suitable cams are parts A0203, A0210 or A0240 - "without projection".

Known application information: h = 26 lh = 18

Therefore; ch = 26 - 18 = +8

Cam off set of +8 is required

Using the data tables for cams A0203, A0210, and A0240 we can select the following cams without projection with an off set of +8; A0203.AW5408 (steel), A0210.AW0428 (stainless) or A0240.AW0108 (three point cam).

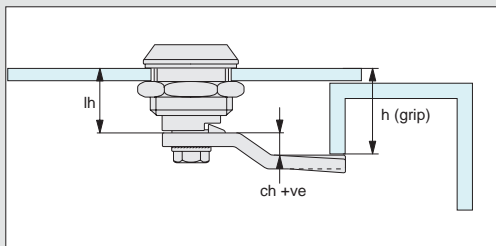

### Example two

Cam body A1003.AW0010 has been selected for the application. If we refer to the data sheet for this part, suitable cams are parts A0203, A0210 or A0240 - "without projection".

Known application information: h = 14 lh = 18

Therefore; ch = 14 - 18 = - 4

The required cam off set is negative, - 4 as the application's door frame is effectively shorter/lower than the length of the cam body

Using the data tables for cams A0203, A0210 and A0240 we can select the following cam without projection with an off set of - 4; A0203.AW6404 (steel).

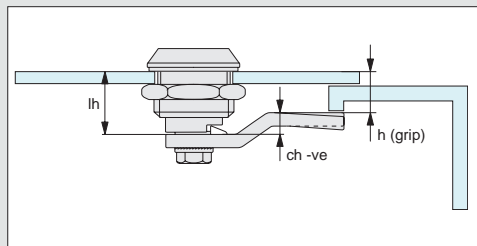

### Example of calculation of correct cam off-set



Suitable With Projection Cams				
Compatible cam no.	<b>A0261</b>	<b>A0203</b>	<b>A0210</b>	<b>A0240</b>
Cam fitting hole	6 x 6 square 	8 x 8 square 	8 x 8 square 	8 x 8 square 
Cam latch / lock no.	A1261 / A1281 / A2390	A2503 / A2504 A2523 / A2528	A2503 / A2504 A2523 / A2528	A2503 / A2504 A2523 / A2528

Suitable Without Projection Cams Table 1				
Compatible cam no.	<b>A0203</b>	<b>A0210</b>	<b>A0240</b>	<b>A0243</b>
Cam fitting hole	8 x 8 square 	8 x 8 square 	8 x 8 square 	8 x 8 square 
Cam latch / lock no.	A1003 / A1021 / A1103 A1161 / A1168 / A1181 A1203 / A1210 / A1251 A1601 / A1620 / A1801 A2001 / A2203 / A2326 A2333 / A2392 / A2526 A4221 / A4241 / A4260 B1082 / B1086 / B1088 B1091 / B1092 / B1180 B1281 / B1285 / B1380 B1450 / B2091 / B2181	A1003 / A1021 / A1103 A1161 / A1168 / A1181 A1203 / A1210 / A1251 A1601 / A1620 / A1801 A2001 / A2203 / A2326 A2333 / A2392 / A2526 A4221 / A4241 / A4260 B1082 / B1086 / B1088 B1091 / B1092 / B1180 B1281 / B1285 / B1380 B1450 / B2091 / B2181	A1003 / A1021 / A1103 A1161 / A1168 / A1181 A1203 / A1210 / A1251 A1601 / A1620 / A1801 A2001 / A2203 / A2326 A2333 / A2392 / A2526 A4221 / A4241 / A4260 B1082 / B1086 / B1088 B1091 / B1092 / B1180 B1281 / B1285 / B1380 B1450 / B2091 / B2181	A1003 / A1021 / A1103 A1161 / A1168 / A1181 A1203 / A1210 / A1251 A1601 / A1620 / A1801 A2001 / A2203 / A2326 A2333 / A2392 / A2526 A4221 / A4241 / A4260 B1082 / B1086 / B1088 B1091 / B1092 / B1180 B1281 / B1285 / B1380 B1450 / B2091 / B2181

Suitable Without Projection Cams Table 2					
Compatible cam no.	<b>A0250</b>	<b>A0234</b>	<b>A0215</b>	<b>A0231</b>	<b>A0233</b>
Cam fitting hole	5 x 5 square 	6,3 dia. x 4,9 	7 x 7 square 	8 x 10 dia. 	8 x 10 dia. 
Cam latch / lock no.	A4600 / A4620	A1661 / A1667	B2082 / B2084 / B2086 B2088 / B2285 / B2380	A1603 / A1611 A1630 / A1810	A1603 / A1611 A1630 / A1810

## Calculation of correct cam off-set

### Cam off-set

Use the formula to calculate your correct cam off-set:

$$ch = h - lh$$

ch = the required cam off-set.

h = distance between inside of lock face and front of cam (also referred to as "grip length").

lh = length of cam body to be used (refer to individual cam body data sheets).

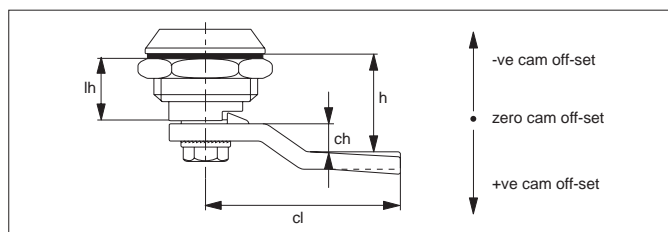

### Cam Off-Set (dimension ch)

To ensure your cam fully and correctly engages with the frame of your door the correct cam off-set must be selected. A cam off-set can be either negative (-ve) or positive (+ve).

### Cam Length (dimension cl)

Impacts reach of the cam to door frame and hence impacts positioning of cam body for installation. Cam length or reach is measured from the centre of the cam fixing hole to the cam's leading edge. Refer to individual cam body datasheets.