

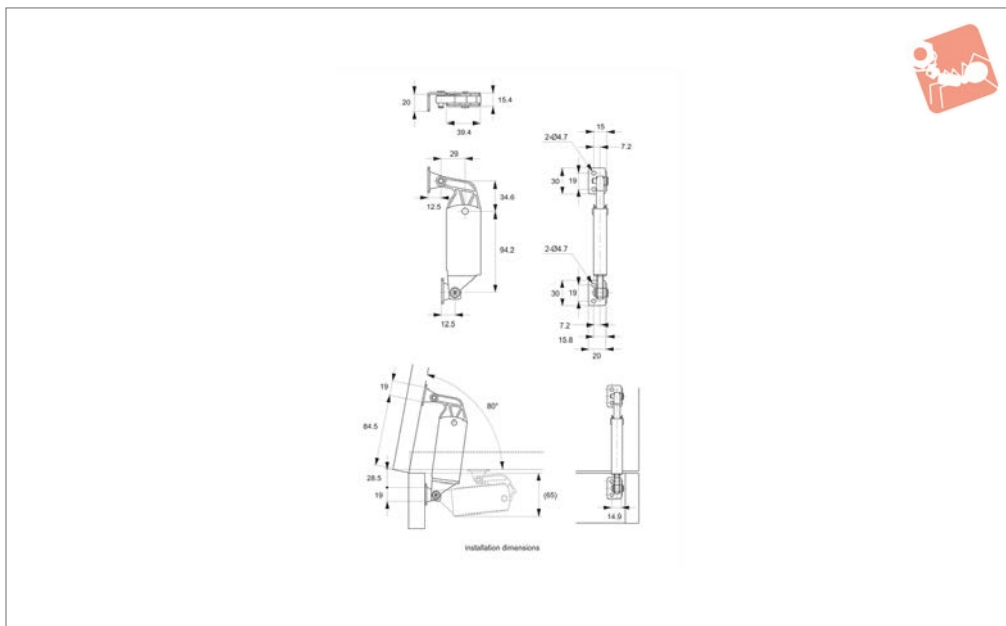

Spring Loaded Lid Stay

heavy duty - back panel mounting

Soft & Spring Stays



N0026

SOFT & SPRING STAYS

Material

Body: stainless steel, AISI 430.
Arm: polyacetal.









Technical Notes

Non-handed, for mounting on left or right panel. Can be installed individually or in

pairs.

Order No.	Torque per piece kgf/cm max.	Lift assist angle
N0026.AC0090	90	10° - 80°
N0026.AC0120	120	10° - 80°



	Mounting			Lid Orientation			Stop Type	Material		Heavy Duty	Max Load Per Single Piece Kg.cm	Retracted Length mm	Max. Length Extended mm	Max Angle
	Right	Left	Universal	Upward	Top (box lid)	Downward		Steel	Stainless Steel					
N0020 	✓	✓		✓			Spring Loaded	✓			30-40	120	151	70°
N0024 			✓	✓			Spring Loaded	✓			90-120	125	158	80°
N0026 			✓	✓			Spring Loaded	✓			90-120	125	158	80°
N0500 			✓	✓			Ratchet	✓			15	148-205	195-290	75-120°
N0550 			✓	✓			Ratchet	✓	✓		20-30	163-305	200-500	80°
N0600 	✓	✓		✓			Multi-stop	✓	✓		70	230-280	350-450	90°
N0620 			✓	✓			Ratchet	✓			15	153	215	90°
N0640 			✓	✓			Mechanical Lock-Pull Release	✓			30	133-170	195-270	90°